

Description

The H9G0810M06P is a LDMOS integrated Asymmetrical Doherty 1-stage Power Amplifier designed for cellular base station applications with 0.63 W average output power covering frequency range from 869 to 960 MHz.

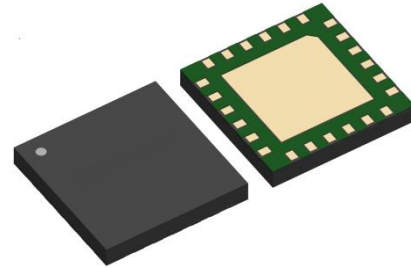

24 Lead LGA 6x6 mm Plastic Package

Block Diagram

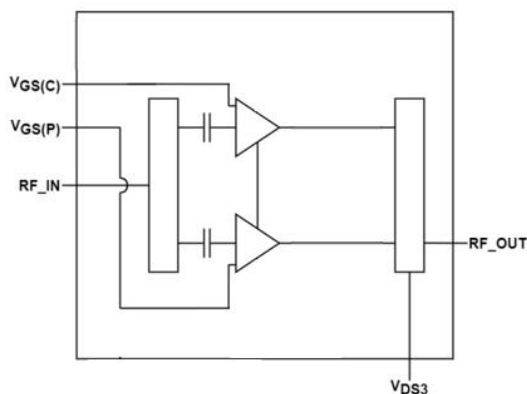

Features

- Operating Frequency Range: 869 to 960 MHz
- Operating Drain Voltage: +28 V
- Saturation Output Power: 5 W
- Integrated Input Divider
- High Efficiency
- High Gain over the Frequency Range
- Small footprint package, 6mm x 6mm LGA

Applications

- 3GPP 5G NR FR1 n5/8/18/26 and 4G-LTE band B5/8/18/26.
- Power Amplifier for Small cells.
- Driver Amplifier for micro and macro base stations.
- Active antenna array for 5G mMIMO.
- Repeaters/DAS.

Order Information

Part Number	Description
H9G0810M06P	Reel Package
H9G0810M06P EVB	869 - 960MHz EVB

Typical Performances

Freq(MHz)	P3dB(dBm)	Gain(dB)	Eff(%)	IRL(dB)
869	37.31	19.46	44.87	-17.80
910	37.33	19.69	46.87	-26.47
960	37.37	19.57	48.53	-22.10

$V_{DD}=28V_{dc}$, $I_{DQ}=18mA$, $V_{gsp}=V_{gsm}-0.8V$, $P_{out}=28\text{ dBm}$, Pulsed CW, 100 us, Duty Cycle = 10%, Test on Holto EVB.

Freq(MHz)	Gain(dB)	Eff(%)	ACPR_5MHz(dBc)	ACPR_10MHz(dBc)
869	19.29	45.49	-32.14	-52.08
910	19.44	46.83	-33.53	-52.50
960	19.32	47.32	-35.65	-53.05

$V_{DD}=28V_{dc}$, $I_{DQ}=18mA$, $V_{gsp}=V_{gsm}-0.8V$, $P_{out}=28\text{ dBm}$, 5MHz WCDMA, PAR=9.9 dB, Test on Holto EVB.

Absolute Maximum Ratings

Parameter	Range/Value	Units
Drain voltage (VDSS)	-0.5 to 65	V
Gate voltage (VGS)	-6 to 10	V
Storage Temperature (TSTG)	-55 to 150	°C
Case Temperature (TC)	-40 to 125	°C
Junction Temperature (TJ)	-40 to 175	°C

Electrical Specification

DC Characteristics

Parameter	Conditions	Min	Typ	Max	Unit
Breakdown Voltage V(BR)DSS	Vgs=0V, Ids=100uA	65	-	-	V
Gate-Source Threshold Voltage VGS(th)	Vgs=Vds, Ids=5.2uA	1.2	-	2	V
Drain Leakage Current IDSS	Vgs=0V, Vds=28V	-	-	0.5	uA
Gate Leakage Current IGSS	Vgs=5V, Vds=0V	-	-	0.05	uA

RF Characteristics (Pulsed CW)

Parameter	Conditions	Min	Typ	Max	Units
Frequency Range	Pout=28 dBm	869	/	960	MHz
P3dB	Freq=960 MHz	36	37	/	dBm

Test conditions, unless otherwise noted: 25 °C, VDD=+28Vdc, IDQ = 18 mA, Vgsp=Vgsm-0.8V, Pulse Width = 100 us, Duty Cycle = 10%,Based on FT board

RF Characteristics (WCDMA)

Parameter	Conditions	Min	Typ	Max	Units
Frequency Range	Pout=28 dBm	869	/	960	MHz
Gain	Freq=960 MHz, Pout=28dBm	18	19	21	dB
Eff	Freq=869 MHz, Pout=28dBm	41.5	45	/	%
Eff	Freq=960 MHz, Pout=28dBm	42.5	47	/	%
ACLR@5MHz	Freq=960 MHz, Pout=28dBm	/	-32	-24	dBc

Test conditions, unless otherwise noted: 25 °C, VDD=+28Vdc, IDQ = 18 mA, Vgsp=Vgsm-0.8V, single-carrier, 5MHz WCDMA signal with 9.9 dB PAR @ 0.01% CCDF Based on FT board

RF Characteristics (Small-Signal)

Parameter	Conditions	Min	Typ	Max	Units
Input Return Loss	Freq=960 MHz	/	/	-9	dB

Test conditions, unless otherwise noted: 25 °C, VDD=+28Vdc, IDQ = 18 mA, Vgsp=Vgsm-0.8V, CW, Based on FT board

Thermal Information

Parameter	Condition	Value (Typ)	Units
Thermal Resistance Junction to Case (RTH)	Tcase= 90°C, WCDMA single-carrier, Pavg = 28 dBm	8.5	C/W

H9G0810M06P 869-960 MHz Reference Design

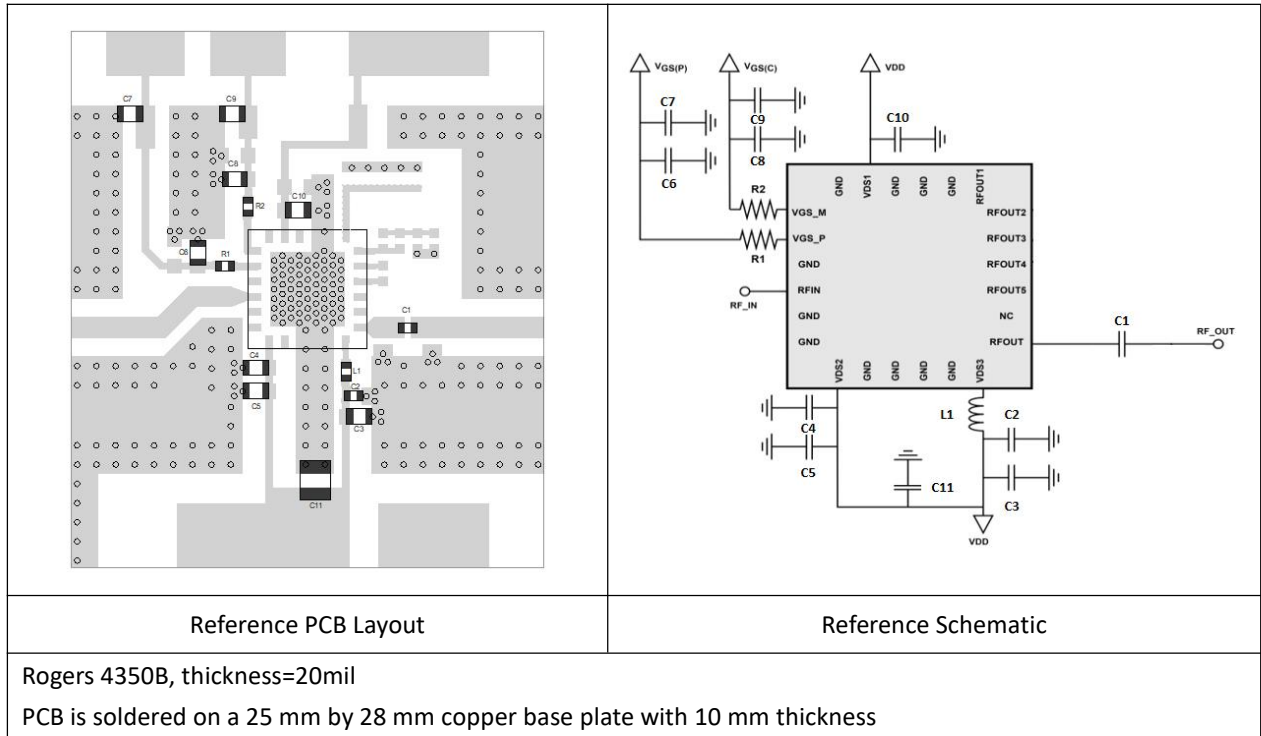

BOM-H9G0810M06P 869 – 960 MHz Reference Design

Component	Type	Value	Description	P/N
C1	Capacitor	20pF	Multi-layer ceramic capacitor	GQM1555C2D200GB01D
C2 - C10	Capacitor	1 uF	Multi-layer ceramic capacitor	GRM21BC72A105KE01L
C11	Capacitor	10 uF	Multi-layer ceramic capacitor	GRM32EC72A106KE05L
L1	Inductor	18nH	HQ inductor	LQW15AN18NG80D
R1, R2	Resistor	0ohm	Resistor	RC0402FR-070RL

Performance Plots

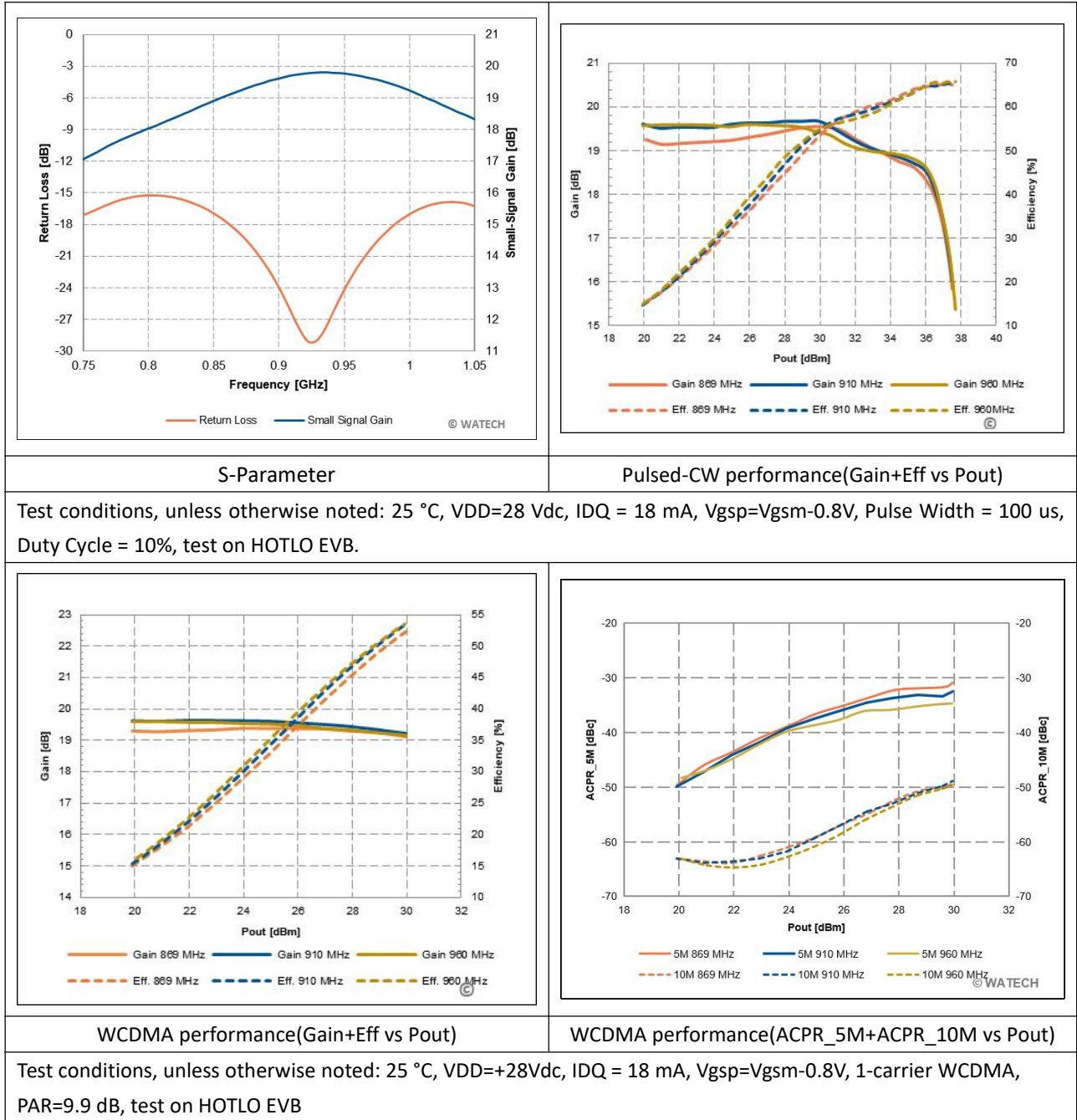

Pin Configuration and Description

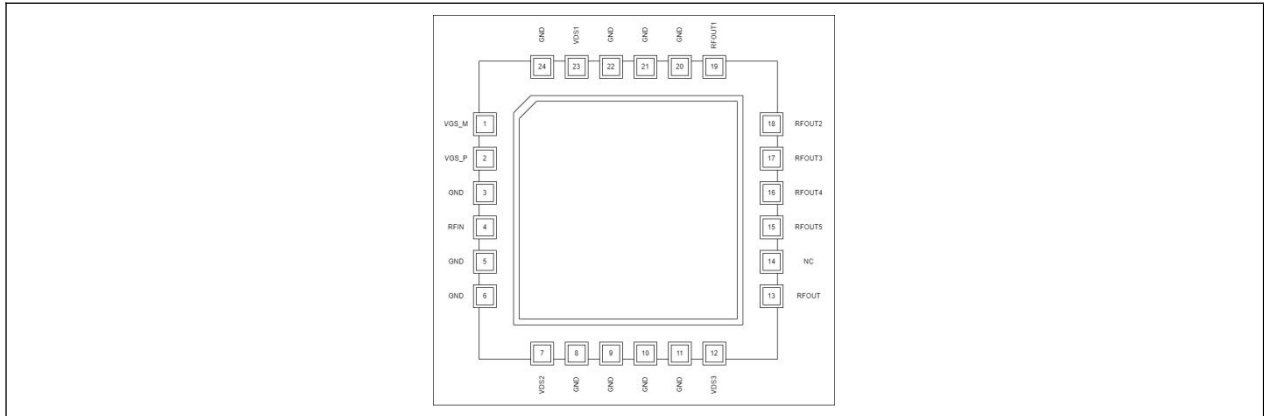

Pin Configuration

Pin Number	Label	Description
1	VGS_M	Gate-source voltage of main
2	VGS_P	Gate-source voltage of peak
3	GND	Ground
4	RFin	RF input
5	GND	Ground
6	GND	Ground
7	VDS2	Drain-source voltage of peak driver
8	GND	Ground
9	GND	Ground
10	GND	Ground
11	GND	Ground
12	VDS3	Drain-source voltage of final stage
13	RFout	RF output
14	NC	NOT CONNECTED
15	RFout5	RF output5
16	RFout4	RF output4
17	RFout3	RF output3
18	RFout2	RF output2
19	RFout1	RF output1
20	GND	Ground
21	GND	Ground
22	GND	Ground
23	VDS1	Drain-source voltage of main driver
24	GND	Ground

Package Marking and Dimensions

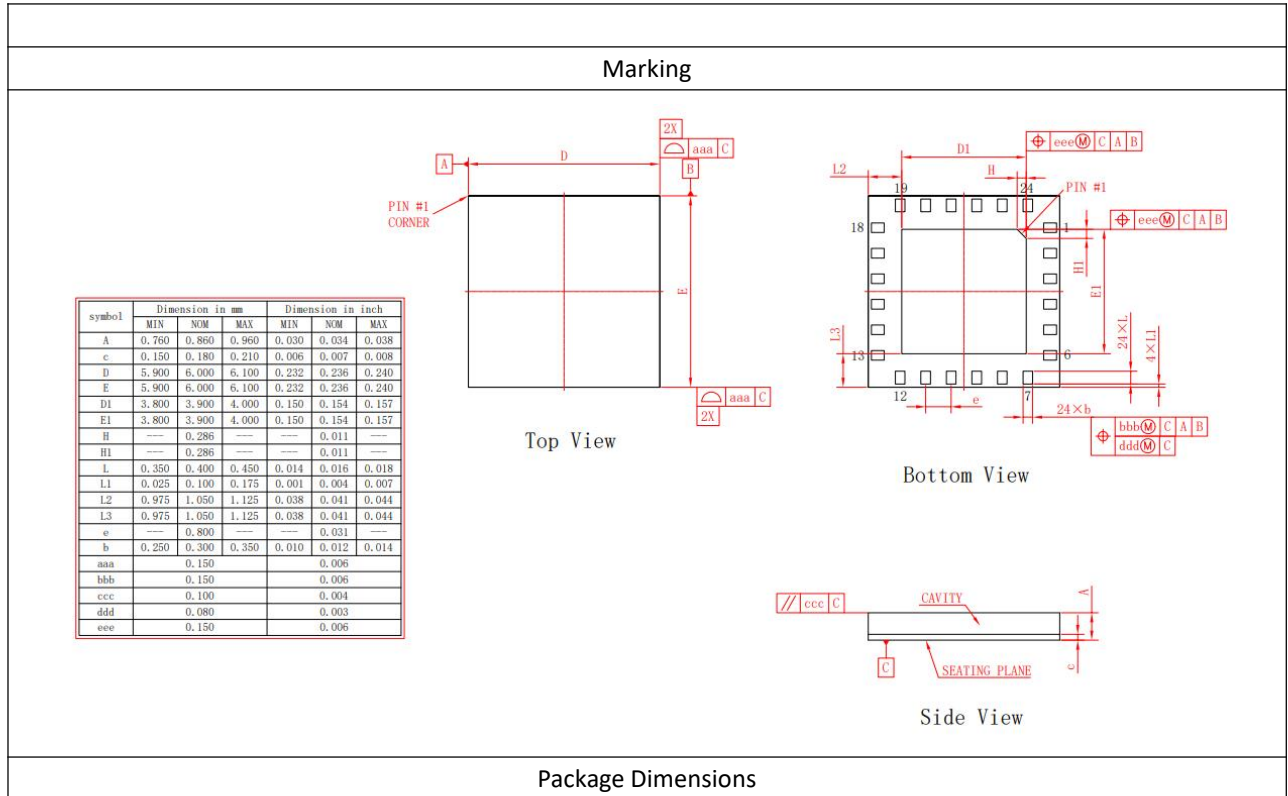

Packing Information

Package Type	Reel Size(inch)	Qty/Reel(pcs)	Qty/Box(pcs)	Qty/Carton(pcs)
LGA 6X6X0.86 24	13	3000	3000	15000

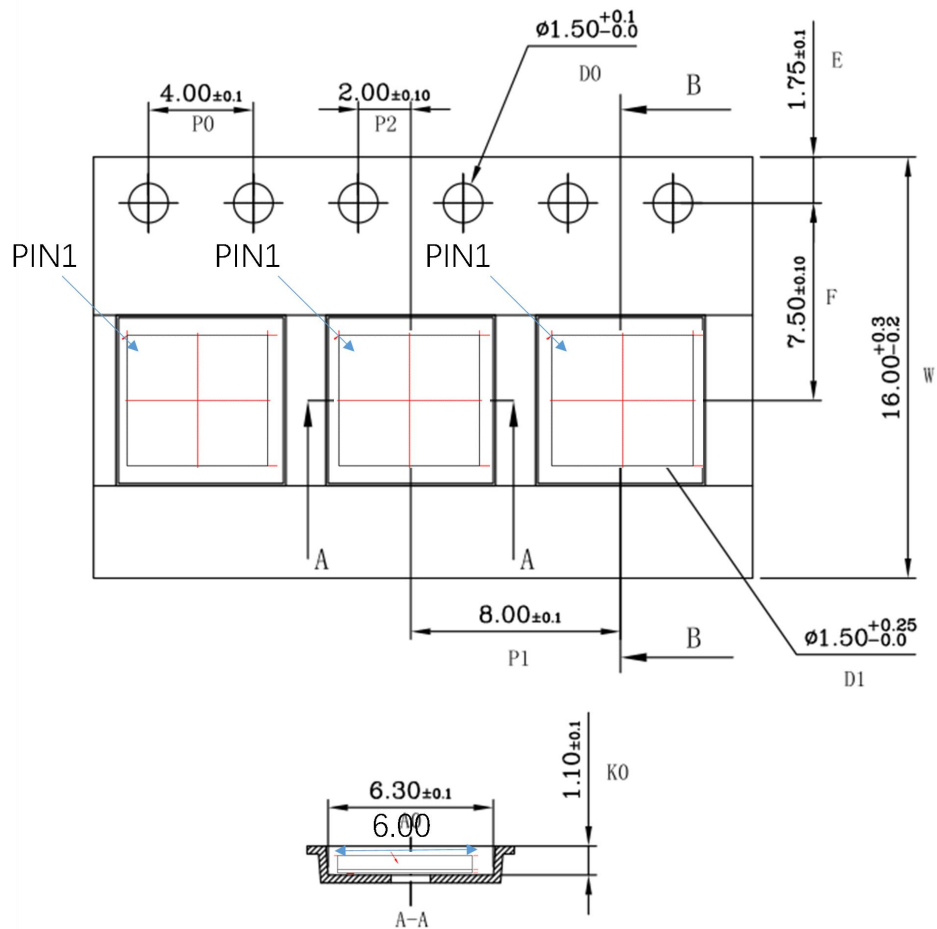

Handling Precautions

Parameter	Rating	Standard	
ESD – Human Body Model (HBM)	1B	ANSI/ESDA/JEDEC Standard JS-001	
ESD – Charged Device Model (CDM)	C1	ANSI/ESDA/JEDEC Standard JS-002	
MSL – 260°C Convection Reflow	MSL3	IPC/JEDEC Standard J-STD-020	

RoHS Compliance

This product is compliant with the 2011/65/EU RoHS directive (Restrictions on the Use of Certain Hazardous Substances in Electrical and Electronic Equipment), as amended by Directive 2015/863/EU.

Policy on Shelf Life

The maximum time devices can be stored under appropriate storage conditions is 3 years.

Datasheet Status

Document status	Product status	Definition
Objective datasheet	Design simulation	Product objective specification
Preliminary datasheet	Customer sample	Engineering samples and first test results
Product datasheet	Mass production	Final product specification

Revision history

Document ID	Datasheet status	Release date	Version revision record
Rev 1.0	Preliminary	April 2024	Preliminary Version
Rev 2.0	Product	May 2024	Product release

Abbreviations

Acronym	Definition
LDMOS	Laterally-diffused metal-oxide semiconductor
GaN	Gallium Nitride
CW	Continuous Waveform
VSWR	Voltage Standing Wave Ratio

Contact Information

For the latest specifications, additional product information, worldwide sales and distribution locations and information about HOTLO:

- Web: www.andesource.com
- Email: andehk@andesource.com

For technical questions and application information:

- Email: andetech@andesource.com

Important Notice

Information in this document is believed to be accurate and reliable. However, HOTLO does not give any representations or warranties, expressed or implied, as to the accuracy or completeness of such information and shall have no liability for the consequences of use of such information.

“Typical” parameters are the average values expected by HOTLO in large quantities and are provided for information purposes only. All information and specifications contained herein are subject to change without notice and customers should obtain and verify the latest relevant information before placing orders for HOTLO products.

The information contained herein or any use of such information does not grant, explicitly or implicitly, to any party any patent rights, licenses, or any other intellectual property rights, whether with regard to such information itself or anything described by such information.

Applications that are described herein for any of these products are for illustrative purposes only. HOTLO makes no representation or warranty that such applications will be suitable for the specified use without further testing or modification. Customers are responsible for the design and operation of their applications and products using HOTLO products, and HOTLO accepts no liability for any assistance with applications or customer product design. It is customer's sole responsibility to determine whether the HOTLO product is suitable and fit for the customer's applications and products planned, as well as for the planned application and use of customer's third-party customer(s). Customers should provide appropriate design and operating safeguards to minimize the risks associated with their applications and products.

HOTLO products are not designed, authorized or warranted to be suitable for use in life support, life-critical or safety-critical systems or equipment, nor in applications where failure or malfunction of a HOTLO product can reasonably be expected to result in personal injury, death or severe property or environmental damage. This document as well as the item(s) described herein may be subject to export control regulations. Export might require a prior authorization from competent authorities.